

SM 1005

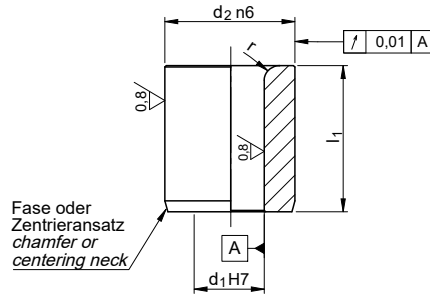





DIN 9845 C

Stempelführungsbuchse

Punch, guide bushing



Catalog No.	Form	d ₁
SM 1005	C	05.10

-  Spezialstahl
special steel
-  gehärtet und geschliffen
hardened and ground
-  HRc 63±1
-  0,1; 0,25; 0,75 mm
über 15 mm 0,5 mm
-  mm
-  andere Materialien und Abmessungen
other materials and dimensions

-  Reinigen mit
SM 1306
Clean with
-  Kleben mit
SM 1300
Lock with

d ₁ Ø H7	d ₂ Ø n6	l ₁	r
00,75 - 01,00	5	9	1,0
01,10 - 02,00	6	12	1,0
02,10 - 03,00	7	12	1,0
03,10 - 04,00	8	12	1,0
04,10 - 05,00	10	16	1,5
05,10 - 06,00	12	16	1,5
06,10 - 08,00	15	20	1,5
08,10 - 10,00	18	20	2,0
10,10 - 12,00	22	28	2,0
12,10 - 15,00	26	28	2,0
15,10 - 18,00	30	36	2,0

SM 10051





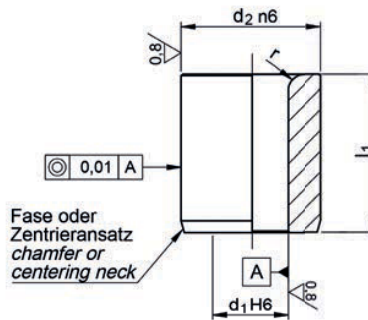

ISO 8978

Stempelführungsbuchse

Punch, guide bushing



Catalog No.	d ₁	X	d ₂	X	l ₁
SM 10051	01.0	X	05	X	08

-  Spezialstahl
special steel
-  gehärtet und geschliffen
hardened and ground
-  HRc 63±1
-  0,1 mm
über 15 mm 0,5 mm
-  andere Materialien und Abmessungen
other materials and dimensions
-  mm

-  Reinigen mit
SM 1306
Clean with
-  Kleben mit
SM 1300
Lock with

d ₁ Ø H6	d ₂ Ø n6	l ₁	r
01,0 - 02,4	05	08,0	1,0
01,6 - 03,0	06	12,5	1,0
02,0 - 03,5	08	12,5	1,5
03,0 - 05,0	10	16,0	1,5
04,0 - 07,2	13	16,0	2,0
06,0 - 08,8	16	20,0	2,0
07,5 - 11,3	20	20,0	2,5
11,0 - 16,6	25	25,0	2,5
15,0 - 20,0	32	25,0	4,0
18,0 - 27,0	40	32,0	4,0
26,0 - 36,0	50	40,0	4,0

